

General Notes

1. Contact Cooperative before installing any equipment or structure.
2. New underground service requires signed easement.
3. Member responsible for mounting meter base and running wire from base to disconnect.
4. Meter base needs to be installed so that the meter is 5' to 5 ½'. The base mounted at minimum of 3' from windows, doors, porches, balconies, ladders, stairs, fire escapes, or other locations accessible to pedestrian traffic.
5. External disconnect required either under or adjacent to meter base.
6. Conduit needs to be schedule 80 grey electric for service wire conduit and ground wire conduit.
7. Member shall provide ground wire with extra 18" of the line once it meets final grade. Ground rod and clamp shall be provided and installed by Cooperative when meter is installed.
8. Conduit for service wire and ground wire installed by member to be 18" below grade. No slip sleeve or long sweep needed unless specified by Cooperative.
9. All conduits within base and disconnect needed bushing and lock rings.
10. Once all above is completed and Aid-to-Construction paid the member can inform Cooperative and the work order can be released for service installation.

General Notes (Continued)

12. The trenching/digging of conductor to service requires area to be at or close to final grade.
13. Cooperative shall trench/dig for the service wire to base. The Cooperative will refill the trench with backfill. The member will be responsible for compacting trench and repairing sidewalks, driveways, etc.
14. Meter base needs to meet NEC code or regional code.

Service Entrance Wire Size

Ground Wire – Bare #6
Between Base and Disconnect – 3/0 Copper



Underground Service Installation "House (UG)"
Single Phase 120/240 Volts, Three Wire, 200 AMP

Detail Notes

- (A) – Meter Base (Cooperative Supplied)
- (B) – 2" PVC Service Conduit
- (C) – ½" PVC Ground Conduit (½" Conduit)
- (D) – Disconnect (Fused)
- (E) – Cooperative Conductor
- (F) – Member's Conductor
- (G) – Ground Wire Screw

Underground Service Installation "House (UG)"
Single Phase 120/240 Volts, Three Wire, 200 AMP

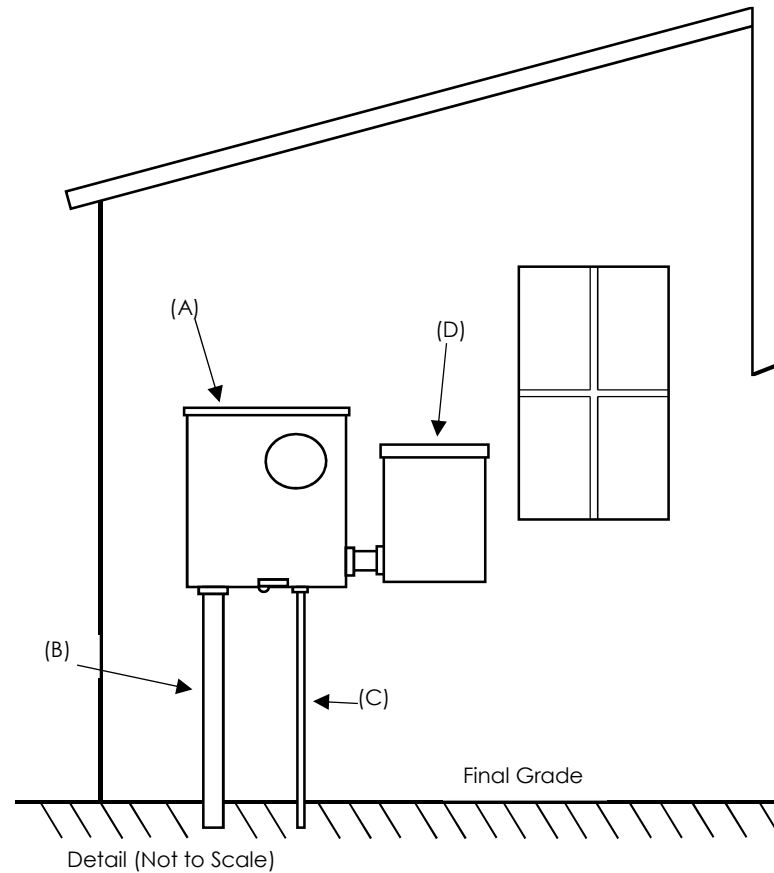
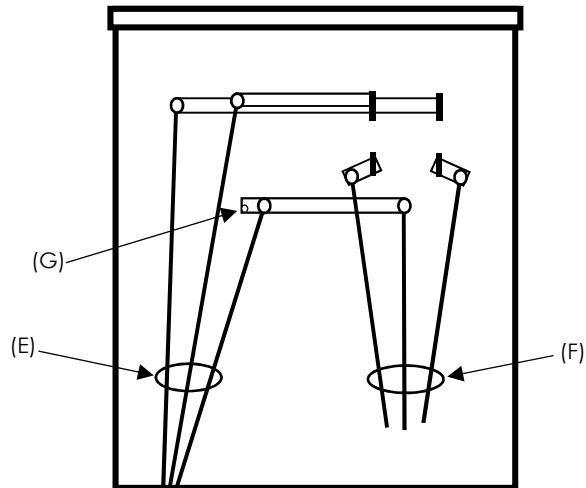

Call Julie before you dig - 800-892-0123